

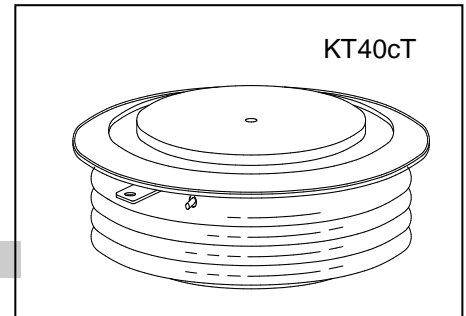

HIGH POWER THYRISTOR FOR PHASE CONTROL APPLICATIONS

Features:

- . All Diffused Structure
- . Amplifying Gate Configuration
- . Blocking capability up to 3200 volts
- . High dv/dt Capability
- . Pressure Assembled Device



ELECTRICAL CHARACTERISTICS AND RATINGS

Blocking - Off State

Device Type	V _{RRM} (1)	V _{DRM} (1)	V _{RSM} (1)
KP500/26	2600	2600	2800
KP500/28	2800	2800	3000
KP500/30	3000	3000	3200
KP500/32	3200	3200	3400

V_{RRM} = Repetitive peak reverse voltage
 V_{DRM} = Repetitive peak off state voltage
 V_{RSM} = Non repetitive peak reverse voltage (2)

Repetitive peak reverse leakage and off state leakage	I _{RRM} /I _{DRM}	2 mA 60 mA (3)
Critical rate of voltage rise	dv/dt (4)	1000 V/μsec

Notes:

- (1) All voltage ratings are specified for an applied 50Hz/60zHz sinusoidal waveform over the temperature range 0 to +125 °C.
- (2) 10 msec. max. pulse width
- (3) Maximum value for T_j = 125 °C.
- (4) Minimum value for linear and exponential waveshape to 67% rated V_{DRM}. Gate open. T_j = 125 °C.
- (5).The value of di/dt is established in accordance with EIA/NIMA Standard JB/T 8950.2-2013

Conducting - On State

Parameter	Symbol	Min.	Max.	Typ.	Units	Conditions
Average value of on-state current	I _{T(AV)}		500		A	Sinewave, 180° conduction, T _c =70°C
RMS value of on-state current	I _{TRMS}		785		A	Nominal value
Peak one cycle surge (non repetitive) current	I _{TSM}		7000		A	10.0 msec (50Hz), sinusoidal wave-shape, 180° conduction, T _j = 125 °C
I square t	I ² t		2.5x10 ⁵		A ² s	10 msec
Latching current	I _L		1000		mA	V _D = 12 V; R _L = 12 ohms
Holding current	I _H		200		mA	V _D = 12 V; I = 2.5 A
Peak on-state voltage	V _{TM}		2.15		V	I _{TM} =1500A; T _j =25°C
Threshold voltage, low-level	V _{TO}		1.03		V	T _j =125°C
Slope resistance, low-level	r _T		0.97		mΩ	500A to 2000A
Critical rate of rise of on-state current	di/dt		150		A/μs	Repetition

Gating

Parameter	Symbol	Min.	Max.	Typ.	Units	Conditions
Peak gate power dissipation	P_{GM}		20		W	
Average gate power dissipation	$P_{G(AV)}$		4		W	
Gate-trigger current	I_{GT}		200		mA	$V_D = 12\text{ V}; R_L = 3\text{ ohms}; T_j = +25\text{ }^\circ\text{C}$
Gate- trigger voltage	V_{GT}	0.70	2.5		V	$V_D = 12\text{ V}; R_L = 3\text{ ohms}; T_j = +25\text{ }^\circ\text{C}$
Peak negative voltage	V_{GRM}		5		V	

Dynamic

Parameter	Symbol	Min.	Max.	Typ.	Units	Conditions
Delay time	t_d		3.0	2.5	μs	$I_{TM} = 50\text{ A}; V_D = 67\% V_{DRM}$ Gate pulse: $V_G = 30\text{ V}; R_G = 10\text{ ohms};$ $t_r = 0.1\mu\text{s}; t_p = 20\mu\text{s}$
Turn-off time (with $V_R = -5\text{ V}$)	t_q			500	μs	$I_{TM} = 500\text{ A}; di/dt = -10\text{ A}/\mu\text{s};$ $V_R = 50\text{ V}; dV/dt = 30\text{ V}/\mu\text{s};$ $V_D = 67\% V_{DRM}; T_j = 125^\circ\text{C}$
Reverse recovery charge	Q_{rr}			2500	μC	$I_{TM} = 500\text{ A}; di/dt = -10\text{ A}/\text{s};$ $V_R = 50\text{ V}; T_j = 125^\circ\text{C}$

THERMAL AND MECHANICAL CHARACTERISTICS AND RATINGS

Parameter	Symbol	Min.	Max.	Typ.	Units	Conditions
Operating temperature	T_j	-40	+125		$^\circ\text{C}$	
Storage temperature	T_{stg}	-40	+140		$^\circ\text{C}$	
Thermal resistance - junction to case	$R_{\theta(j-c)}$		0.04		$^\circ\text{C}/\text{W}$	Double sided cooled
Thermal resistance - case to heatsink	$R_{\theta(c-s)}$		0.008		$^\circ\text{C}/\text{W}$	Double sided cooled
Mounting force	P	13	17	15	kN	
Weight	W			0.26	kg	

* Mounting surfaces smooth, flat and greased

